

3D CAD MASTER PART NAME :

ALL DIMENSIONS IN INCHES

SIEMENS		Michigan Technological University	
FIRST ISSUED		TITLE	Overview
DRAWN BY		SIZE	D
CHECKED BY		DRG NO.	Final Box 6
APPROVED BY	Shawbitz Kevin	REV	1
SCALE 1:5		SHEET 1 OF 1	

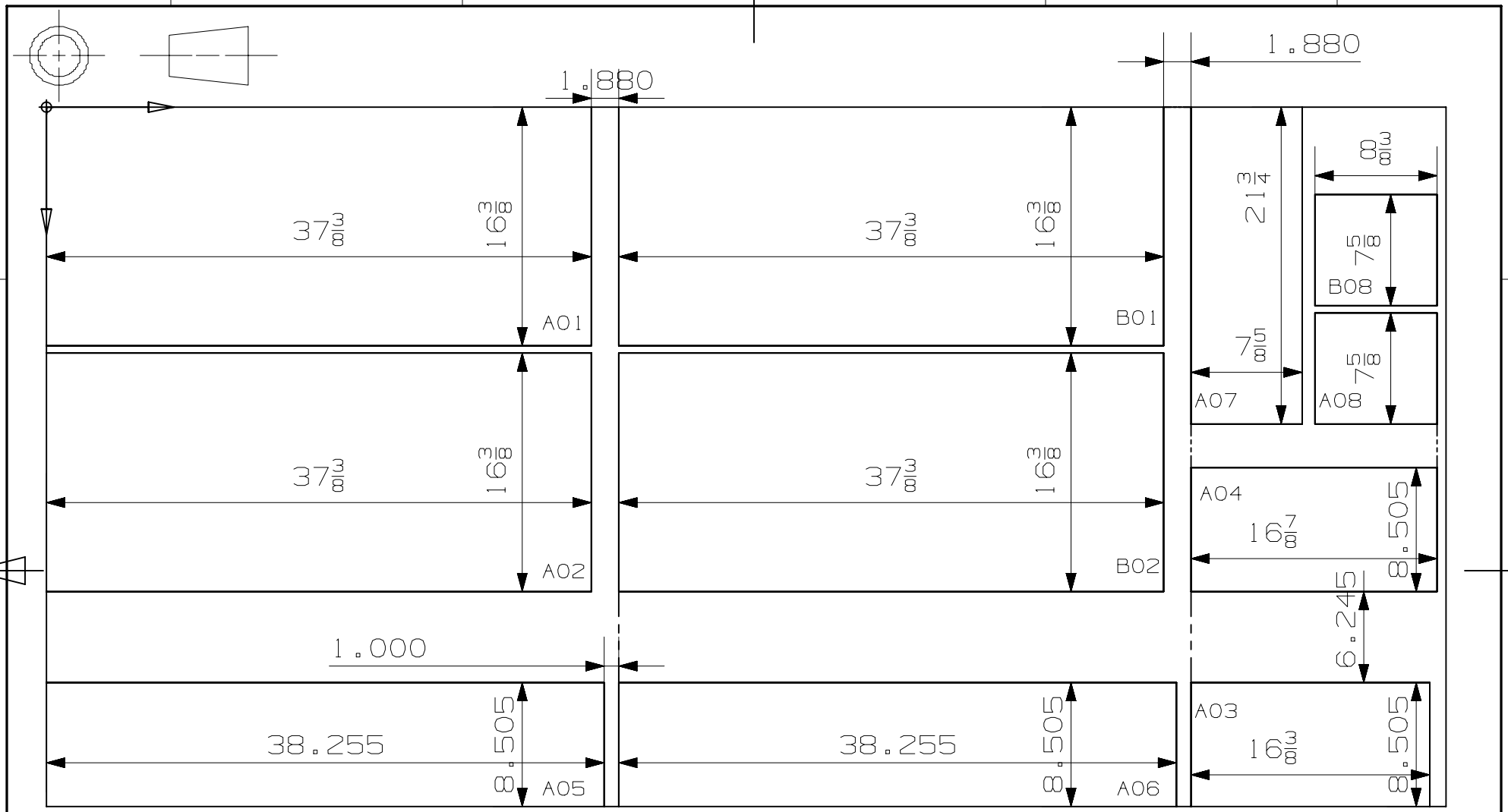

SIEMENS

Michigan Technological University

FIRST ISSUED	
DRAWN BY	
CHECKED BY	
APPROVED BY	
Shawbitz Kevin	

TITLE		
4' x 8' Plywood Cutout		
SIZE	DRG NO.	REV
A	Board 1 Rev 3-8-2013	4

ALL DIMENSIONS IN INCHES
3D CAD MASTER PART NAME:

SCALE 1:10	SHEET 1 OF 1
------------	--------------

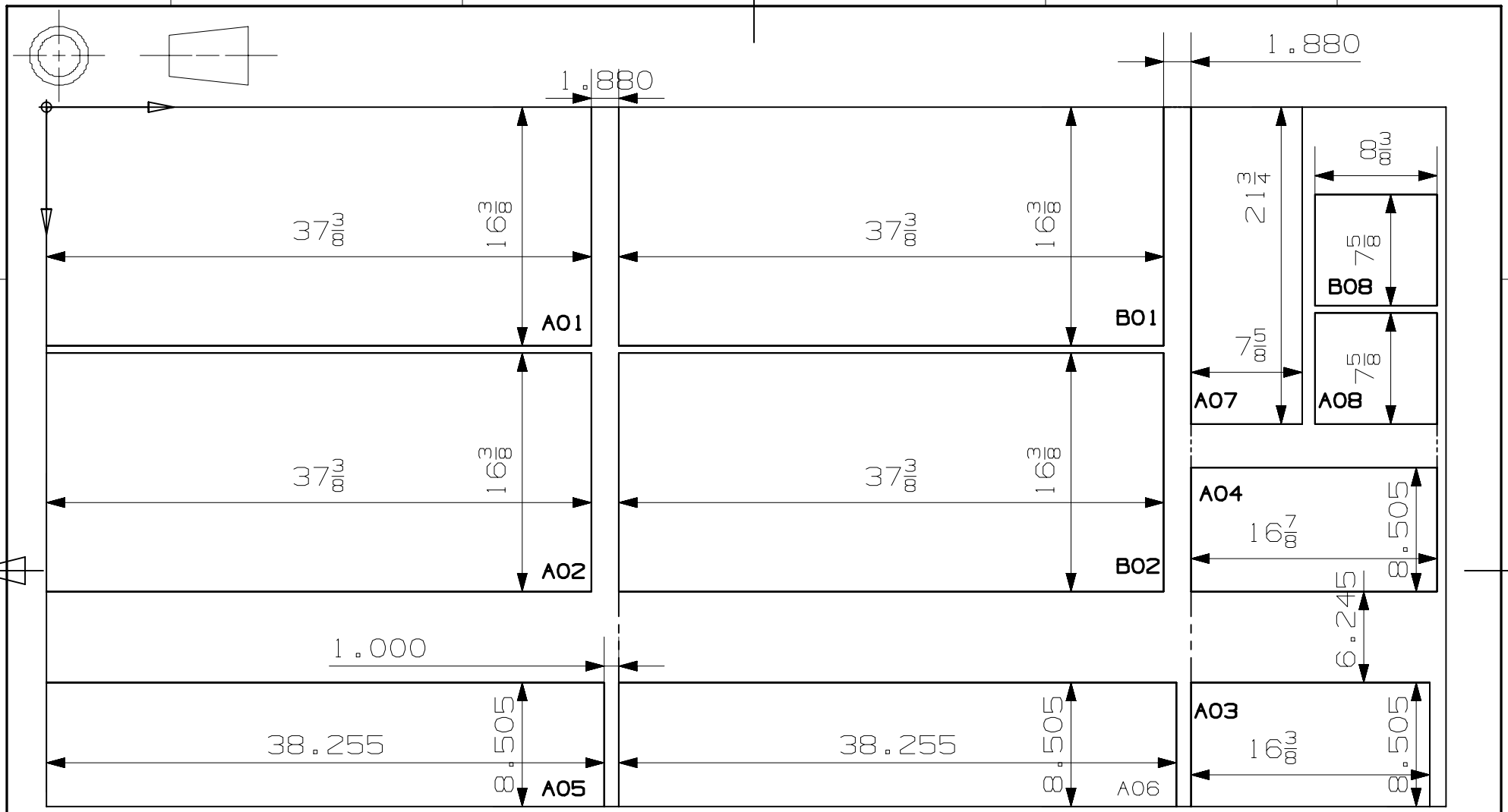

SIEMENS

Michigan Technological University

FIRST ISSUED
 DRAWN BY
 CHECKED BY
 APPROVED BY
 Shawbitz Kevin

TITLE
 4' x 8' Plywood Cutout
 SIZE DRG NO.
 A Board 1 Rev 3-8-2013
 REV
 4

ALL DIMENSIONS IN INCHES
 3D CAD MASTER PART NAME:

SCALE 1:10 SHEET 1 OF 1

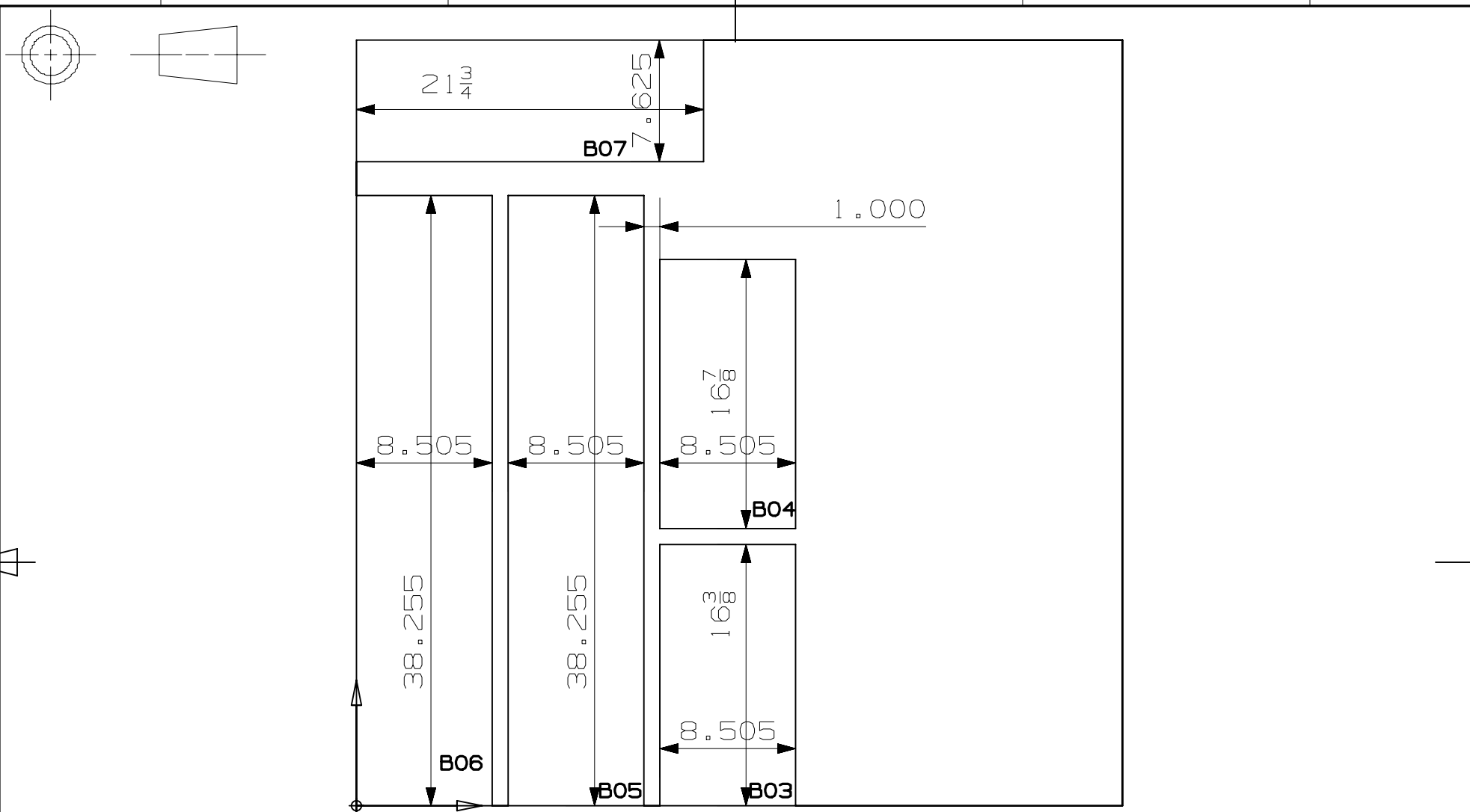

SIEMENS

Michigan Technological University

FIRST ISSUED
 DRAWN BY
 CHECKED BY
 APPROVED BY
 Shawbitz Kevin

TITLE
 4' x 4' Plywood Cutout
 SIZE DRG NO. REV
 A Plywood Cutout 2 4

ALL DIMENSIONS IN INCHES
 3D CAD MASTER PART NAME:

SCALE 1:9 SHEET 1 OF 1

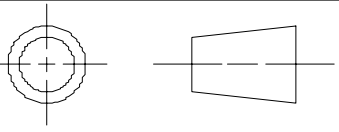

16.250
1.000

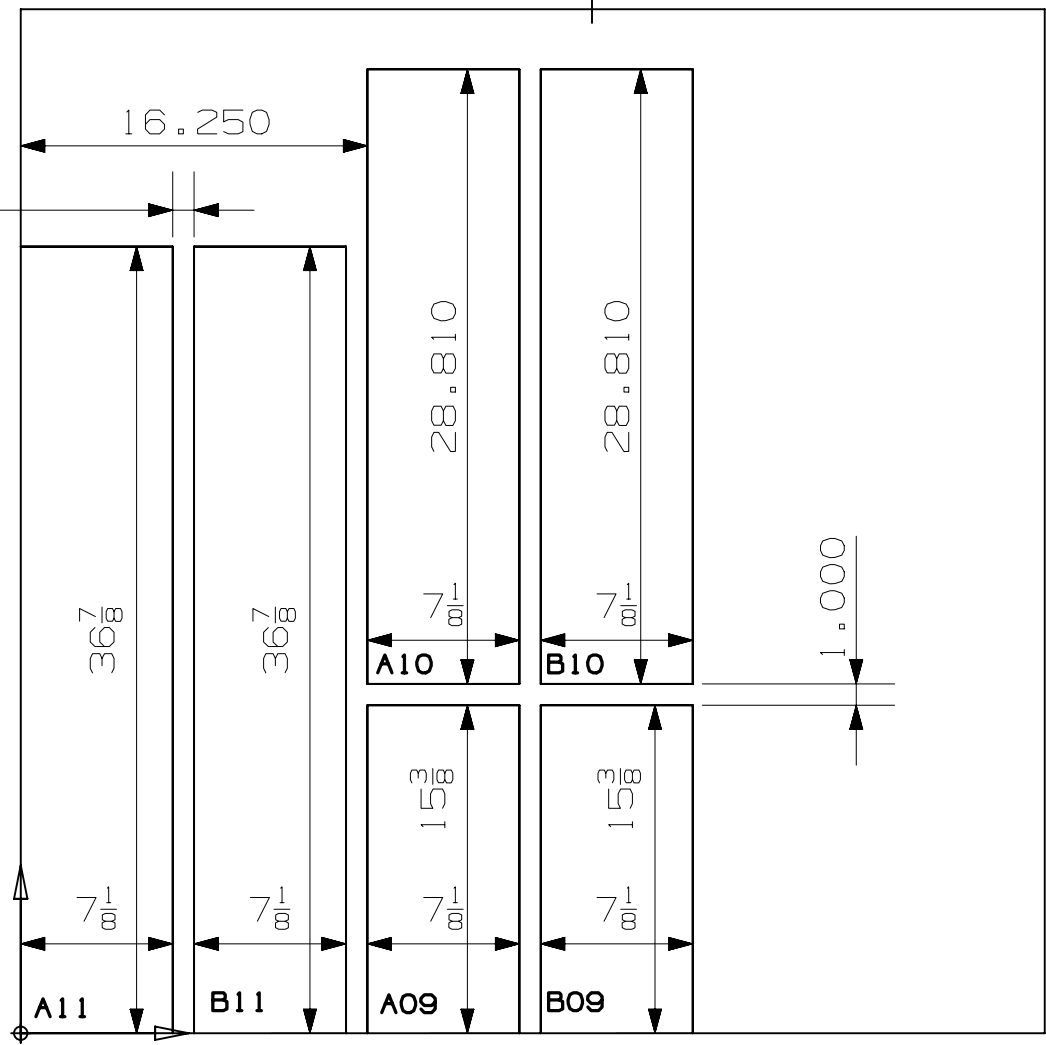

SIEMENS

Michigan Technological University

FIRST ISSUED	
DRAWN BY	
CHECKED BY	
APPROVED BY	
Shawbitz Kevin	

TITLE	
4" x 4" MDF Cutout	
SIZE	DRG NO.
A	MDF Cutout
REV	
3	
SCALE 1:9	SHEET 1 OF 1

ALL DIMENSIONS IN INCHES
3D CAD MASTER PART NAME:

1 2 3 4 5 6

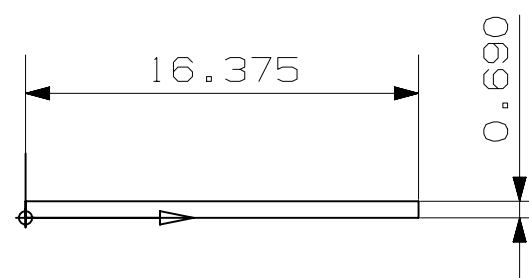
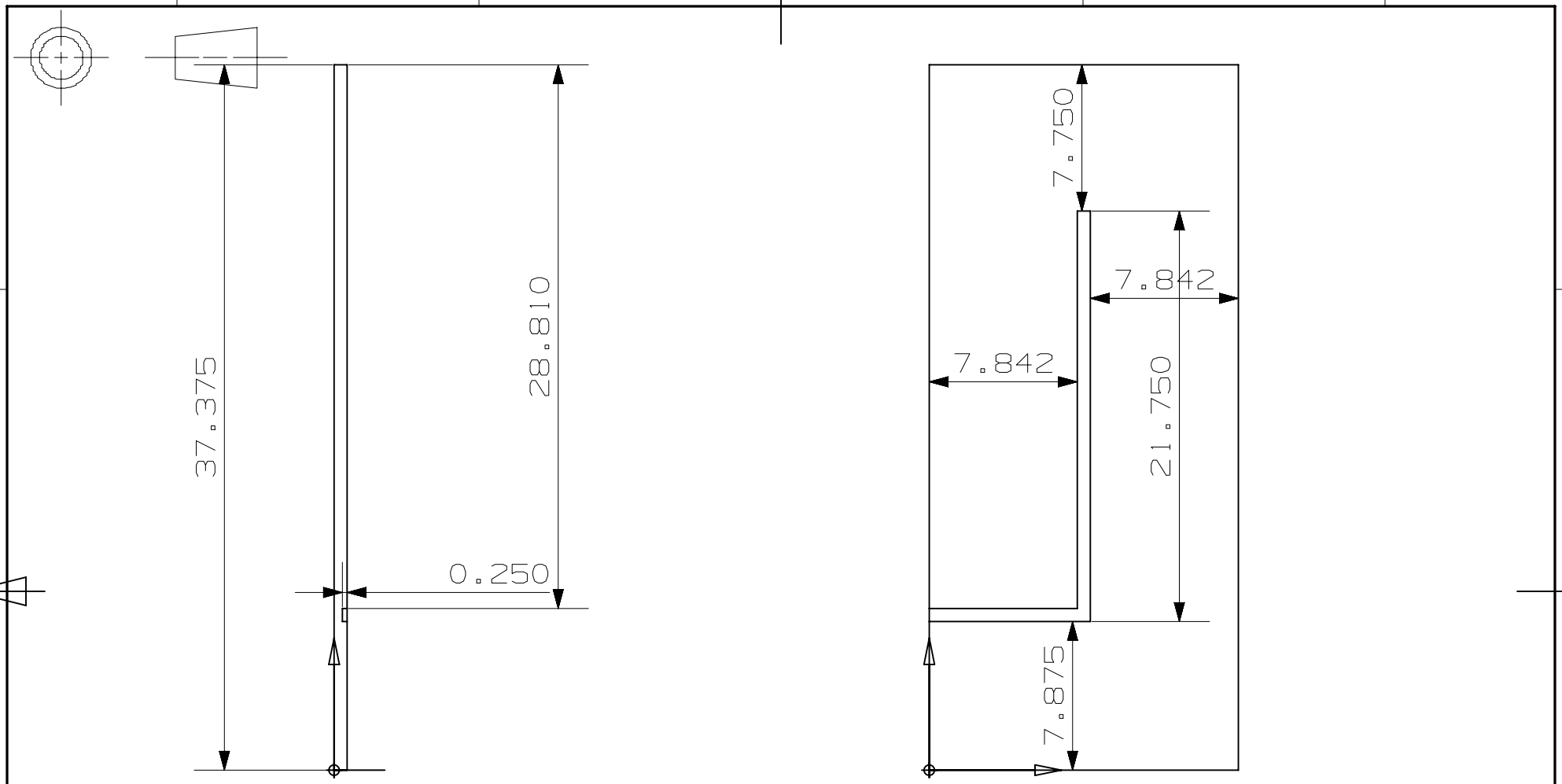

SIEMENS		Michigan Technological University		
FIRST ISSUED		TITLE		
DRAWN BY		Left Side - Plywood		
CHECKED BY		SIZE	DRG NO.	REV
APPROVED BY		A	01	3
Shawbitz Kevin		SCALE 1:8	SHEET 1 OF 1	

ALL DIMENSIONS IN INCHES
 3D CAD MASTER PART NAME:

1 2 3 4 5 6

A A

B B

C C

D D

1 2 3 4 5 6

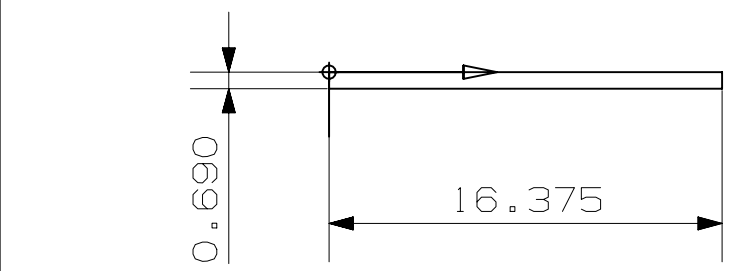
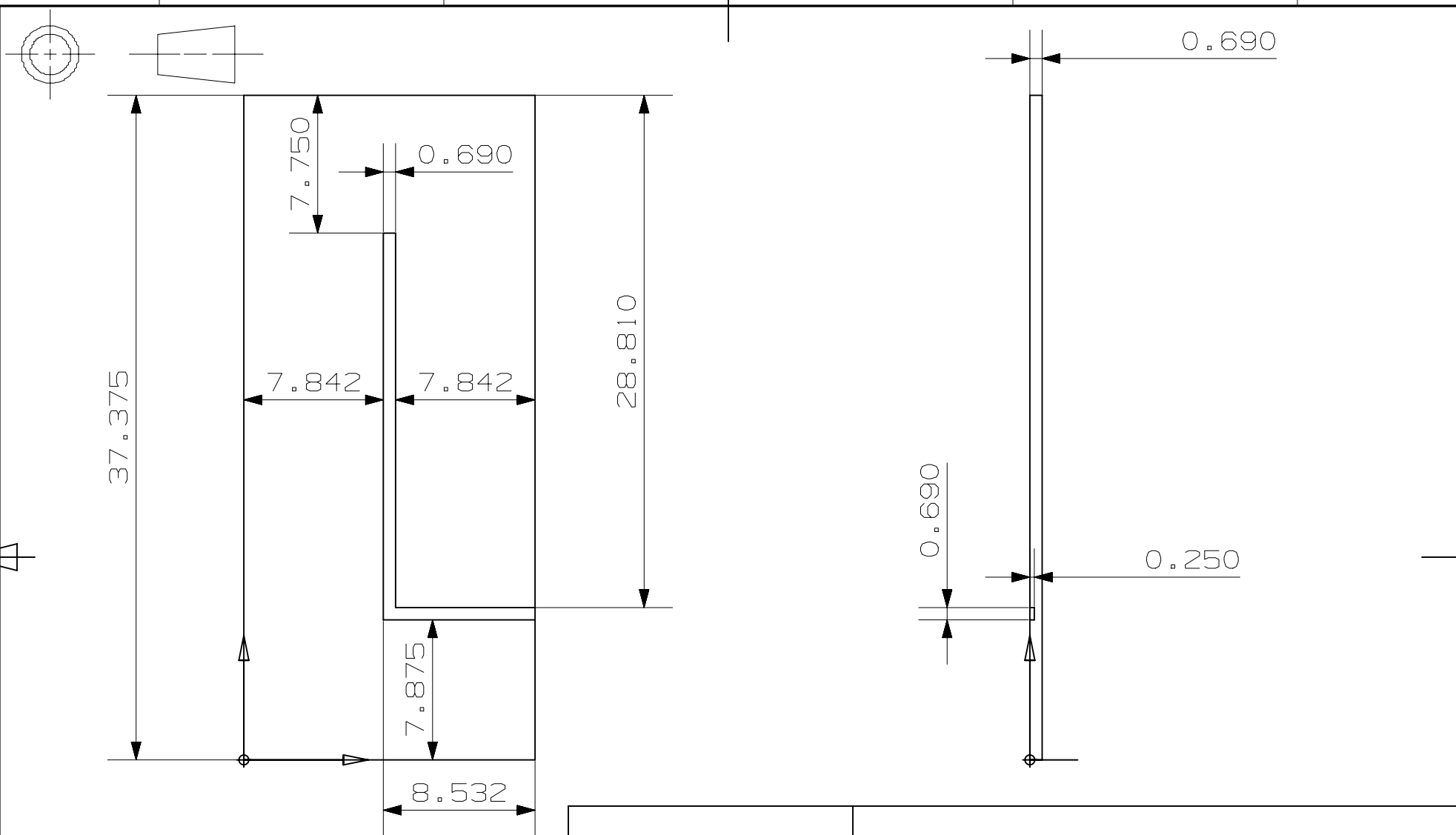

ALL DIMENSIONS IN INCHES
 3D CAD MASTER PART NAME:

SIEMENS		Michigan Technological University		
		TITLE Right Side - Plywood		
FIRST ISSUED		SIZE	DRG NO.	REV
DRAWN BY		A	02	3
CHECKED BY				
APPROVED BY				
Shawbitz Kevin		SCALE 1:8		SHEET 1 OF 1

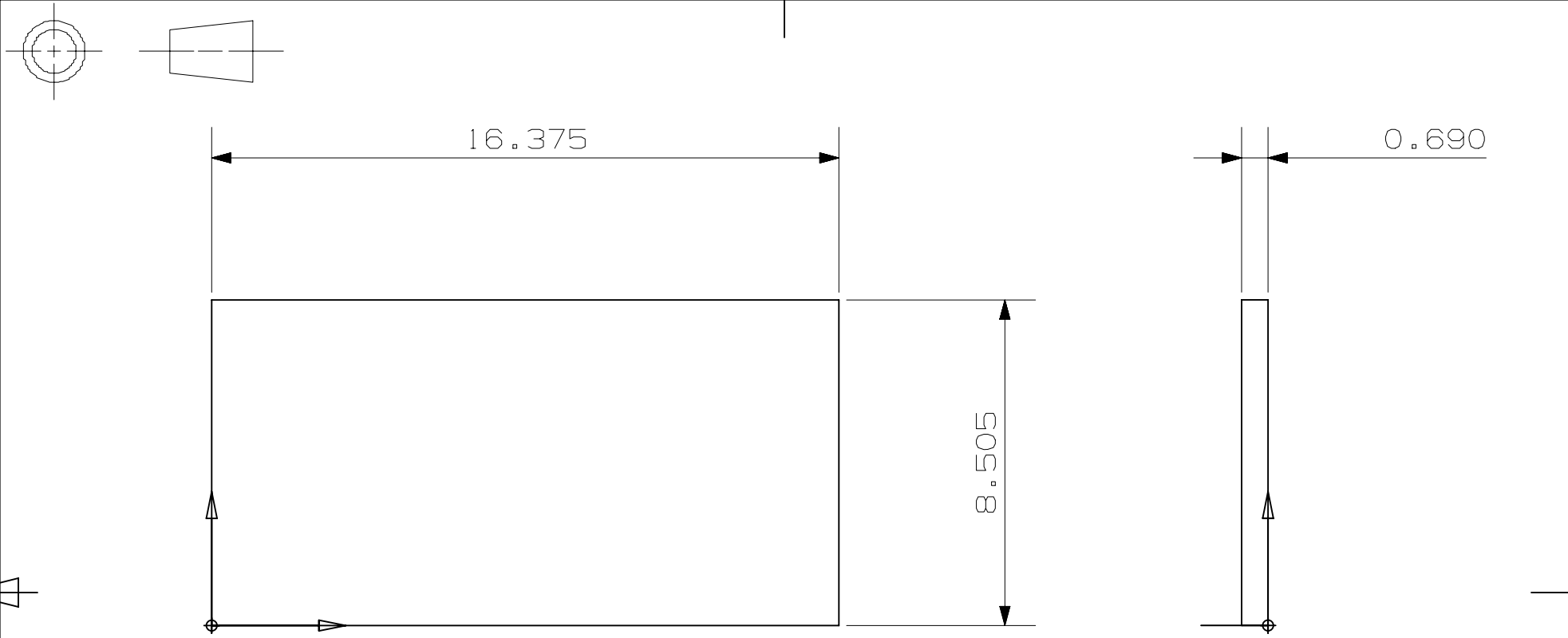

SIEMENS

Michigan Technological University

FIRST ISSUED
 DRAWN BY
 CHECKED BY
 APPROVED BY
 Shawbitz Kevin

TITLE
 Top - Plywood

SIZE DRG NO. REV
 A 03 3

ALL DIMENSIONS IN INCHES
 3D CAD MASTER PART NAME:

SCALE 1:4 SHEET 1 OF 1

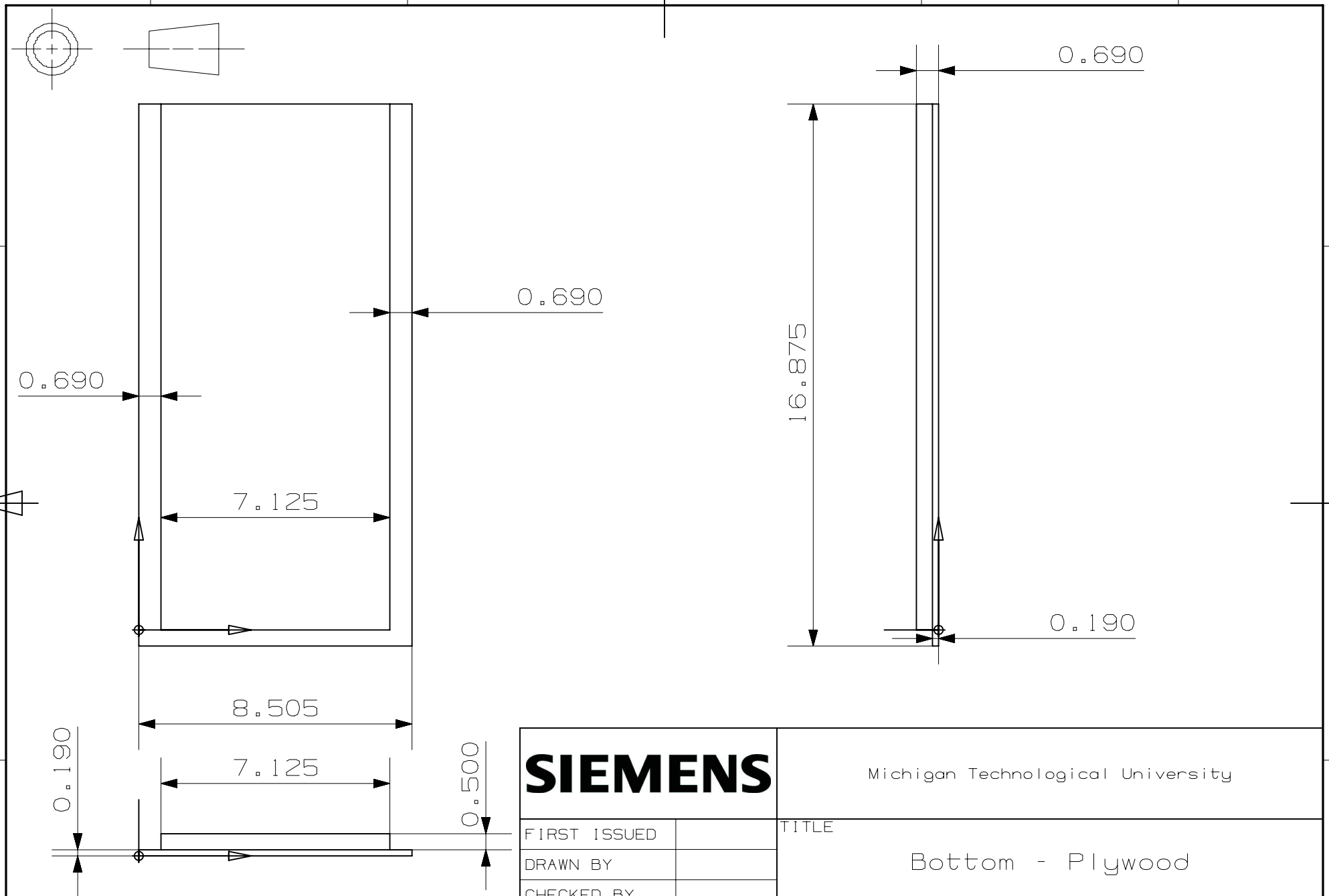

ALL DIMENSIONS IN INCHES

3D CAD MASTER PART NAME:

SIEMENS

Michigan Technological University

FIRST ISSUED	
DRAWN BY	
CHECKED BY	
APPROVED BY	
Shawbitz Kevin	

TITLE		
Bottom - Plywood		
SIZE	DRG NO.	REV
A	04	3

SCALE 1:4

SHEET 1 OF 1

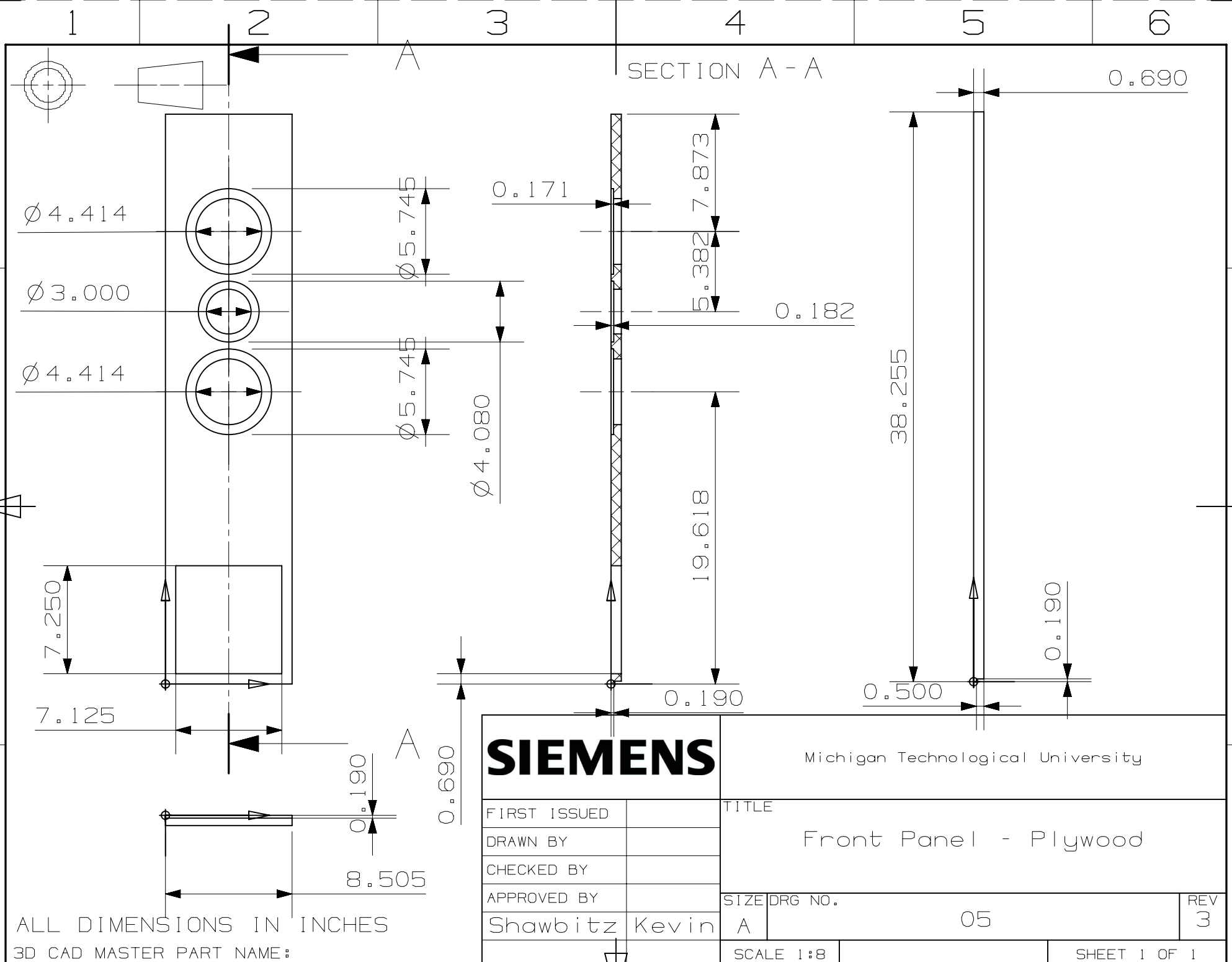

ALL DIMENSIONS IN INCHES

3D CAD MASTER PART NAME:

SIEMENS

Michigan Technological University

FIRST ISSUED	
DRAWN BY	
CHECKED BY	
APPROVED BY	
Shawbitz Kevin	

TITLE	
Front Panel - Plywood	
SIZE	DRG NO.
A	05
	REV
	3

SCALE 1:8

SHEET 1 OF 1

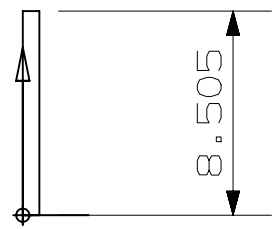
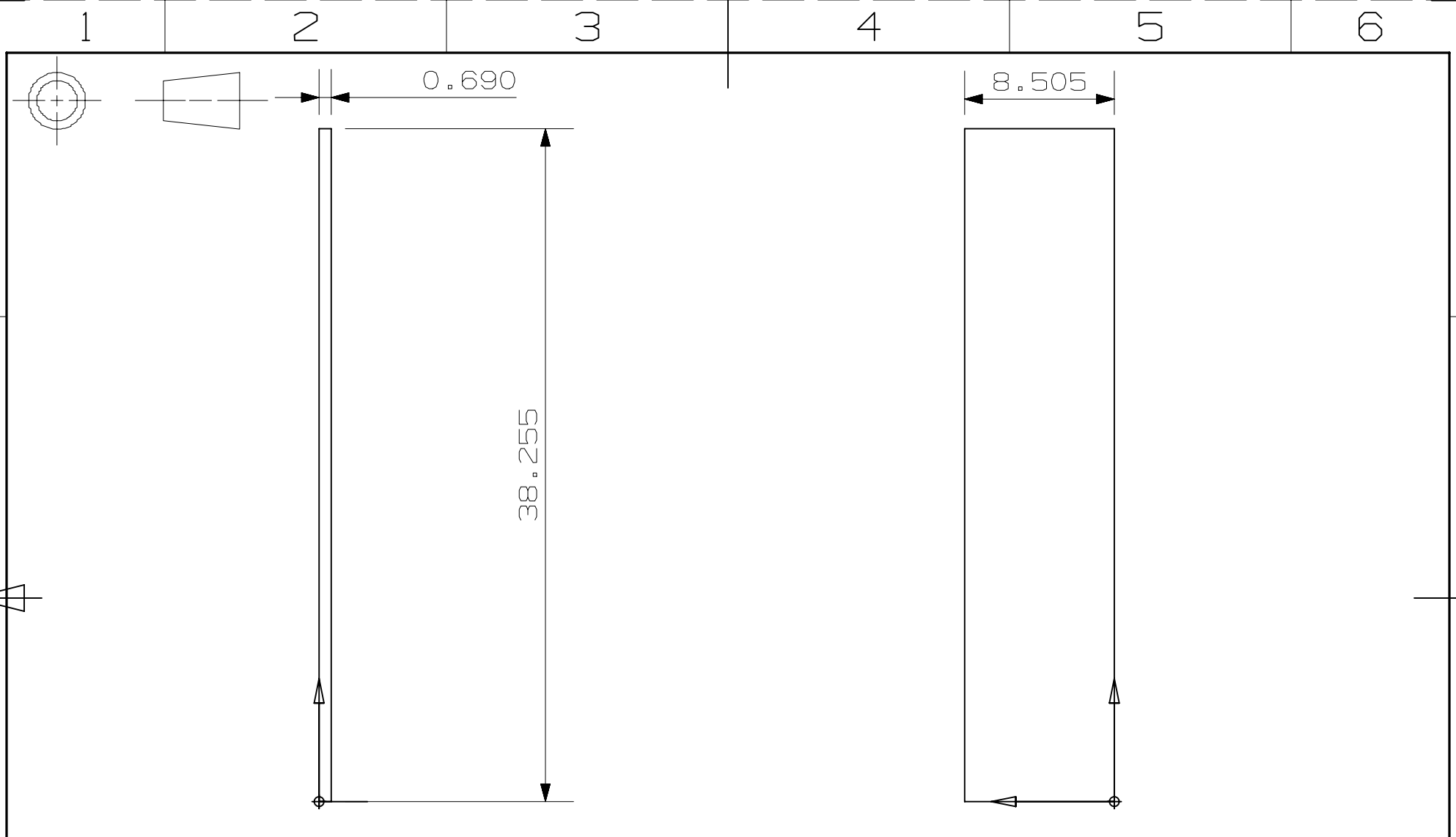

SIEMENS		Michigan Technological University		
		TITLE Back Panel - Plywood		
FIRST ISSUED		SIZE	DRG NO.	REV
DRAWN BY		A	06	3
CHECKED BY				
APPROVED BY				
Shawbitz Kevin		SCALE 1:8		SHEET 1 OF 1

ALL DIMENSIONS IN INCHES
3D CAD MASTER PART NAME:

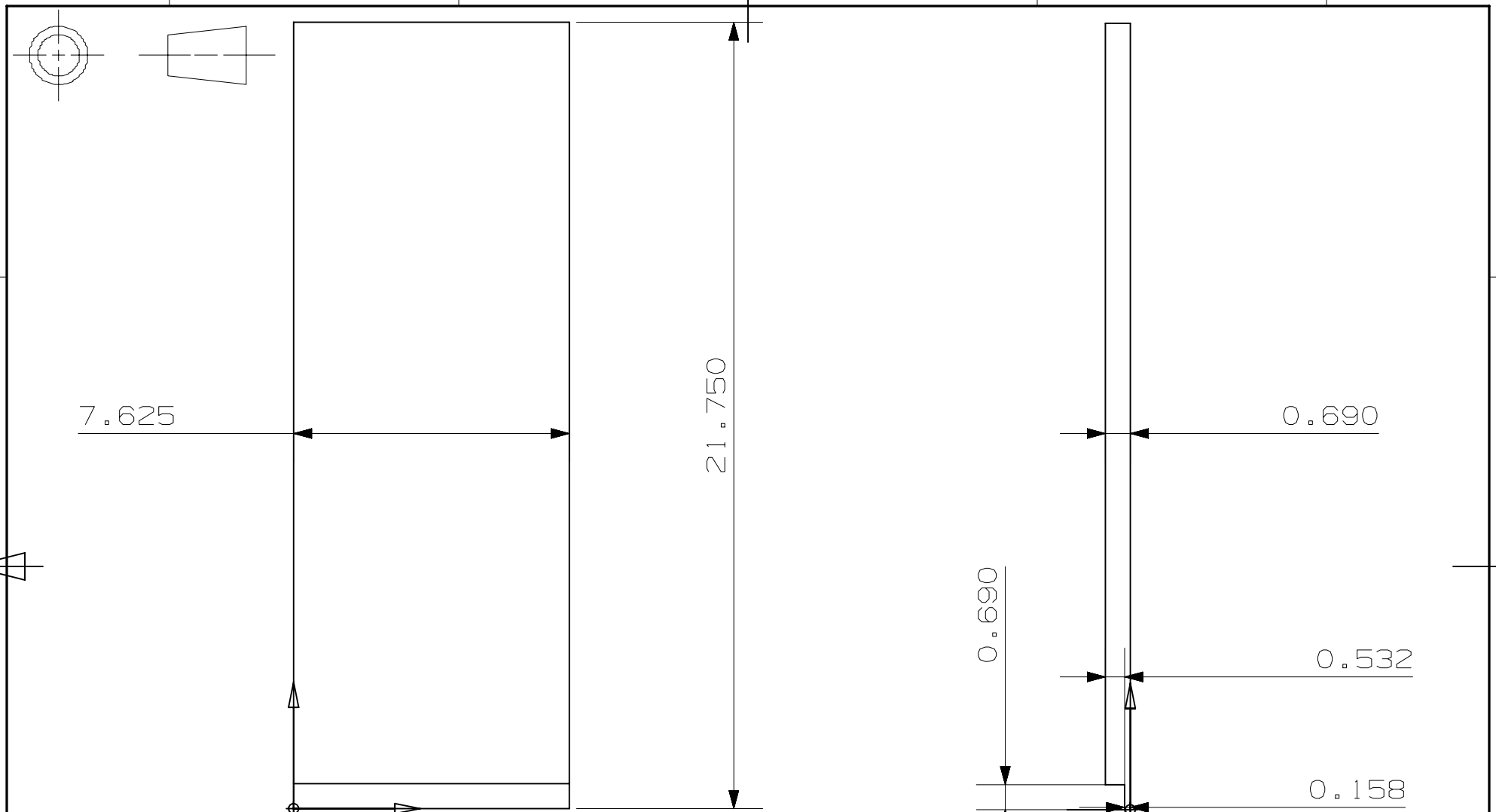

SIEMENS

Michigan Technological University

FIRST ISSUED	
DRAWN BY	
CHECKED BY	
APPROVED BY	
Shawbitz Kevin	

TITLE
Transmission Line Long
Brace - Plywood

SIZE	DRG NO.	REV
A	07	3

ALL DIMENSIONS IN INCHES

3D CAD MASTER PART NAME:

SCALE 1:4	SHEET 1 OF 1
-----------	--------------

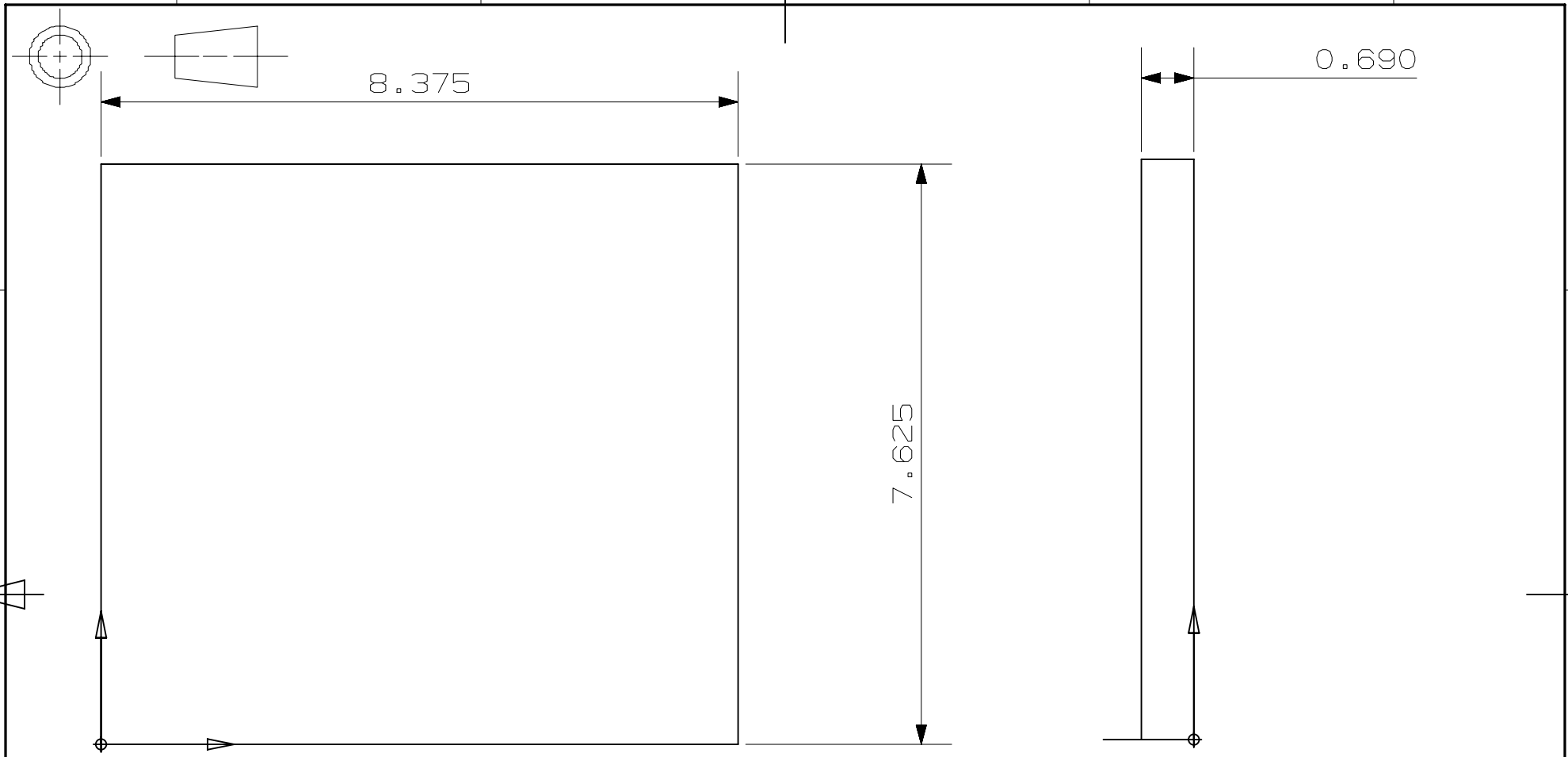

SIEMENS

Michigan Technological University

FIRST ISSUED	
DRAWN BY	
CHECKED BY	
APPROVED BY	
Shawbitz Kevin	

TITLE		
Transmission Line Short Brace - Plywood		
SIZE	DRG NO.	REV
A	08	3

ALL DIMENSIONS IN INCHES

3D CAD MASTER PART NAME :

SCALE 1:2

SHEET 1 OF 1

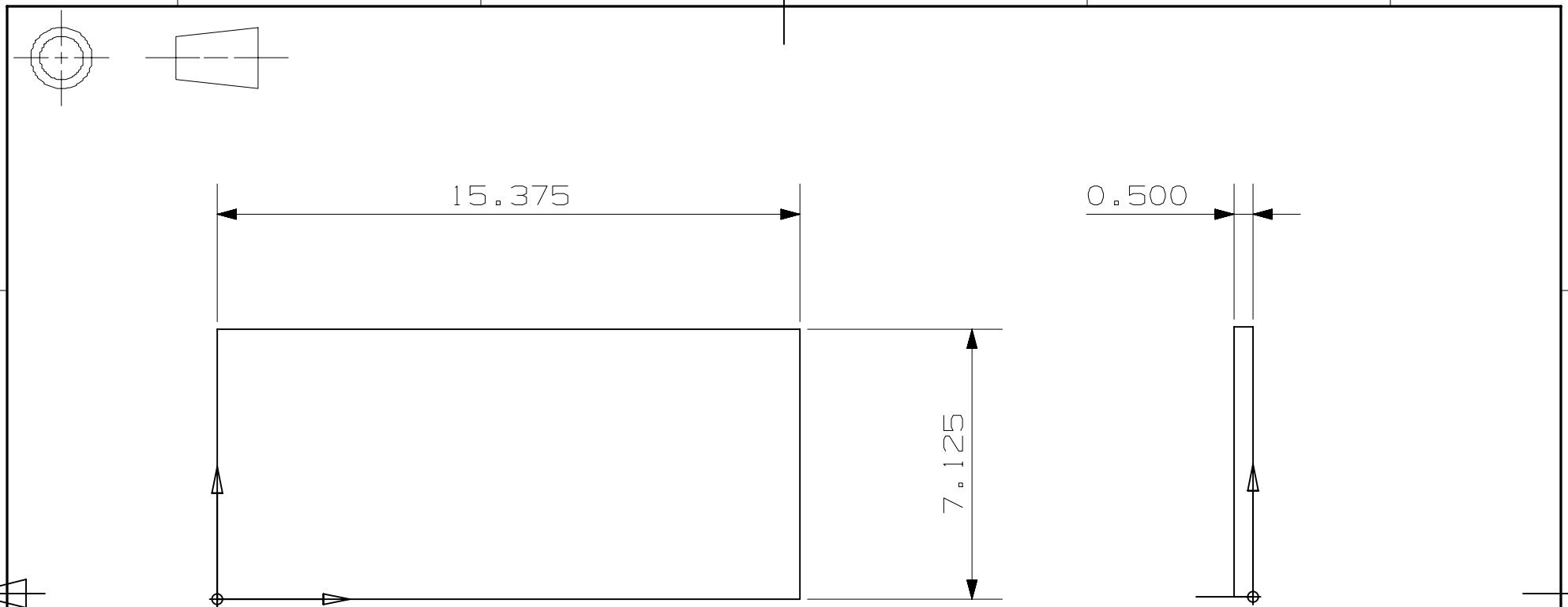

SIEMENS

Michigan Technological University

FIRST ISSUED
 DRAWN BY
 CHECKED BY
 APPROVED BY
 Shawbitz Kevin

TITLE
 Top - MDF
 SIZE DRG NO. REV
 A 09 3

ALL DIMENSIONS IN INCHES

3D CAD MASTER PART NAME:

SCALE 1:4

SHEET 1 OF 1

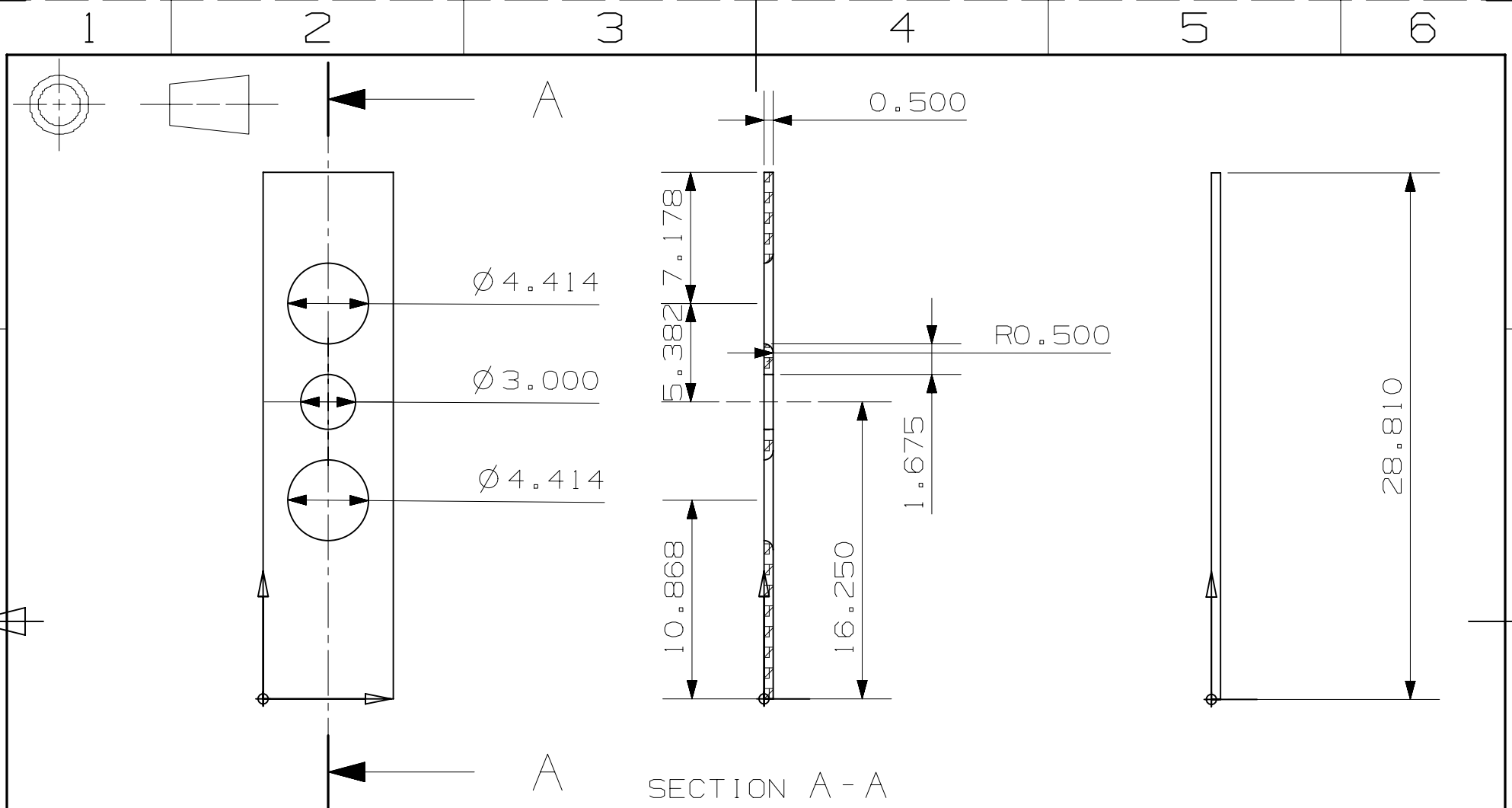

SECTION A - A

ALL DIMENSIONS IN INCHES

3D CAD MASTER PART NAME:

SIEMENS

Michigan Technological University

FIRST ISSUED	
DRAWN BY	
CHECKED BY	
APPROVED BY	
Shawbitz Kevin	

TITLE		
Front Panel - MDF		
SIZE	DRG NO.	REV
A	10	3

SCALE 1:8

SHEET 1 OF 1

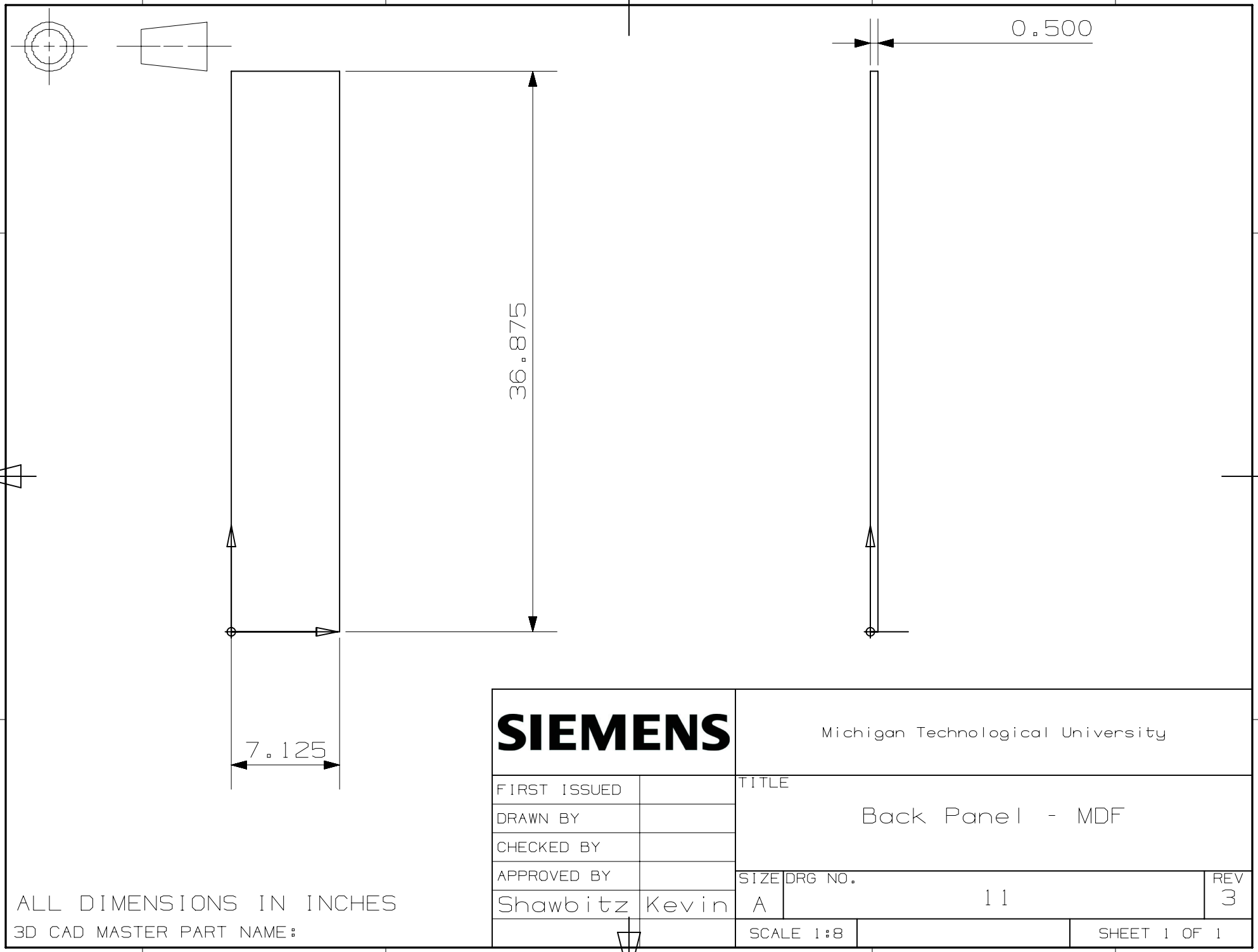

SIEMENS

Michigan Technological University

FIRST ISSUED	
DRAWN BY	
CHECKED BY	
APPROVED BY	
Shawbitz Kevin	

TITLE		
Back Panel - MDF		
SIZE	DRG NO.	REV
A	11	3

ALL DIMENSIONS IN INCHES
3D CAD MASTER PART NAME:

SCALE 1:8	SHEET 1 OF 1
-----------	--------------

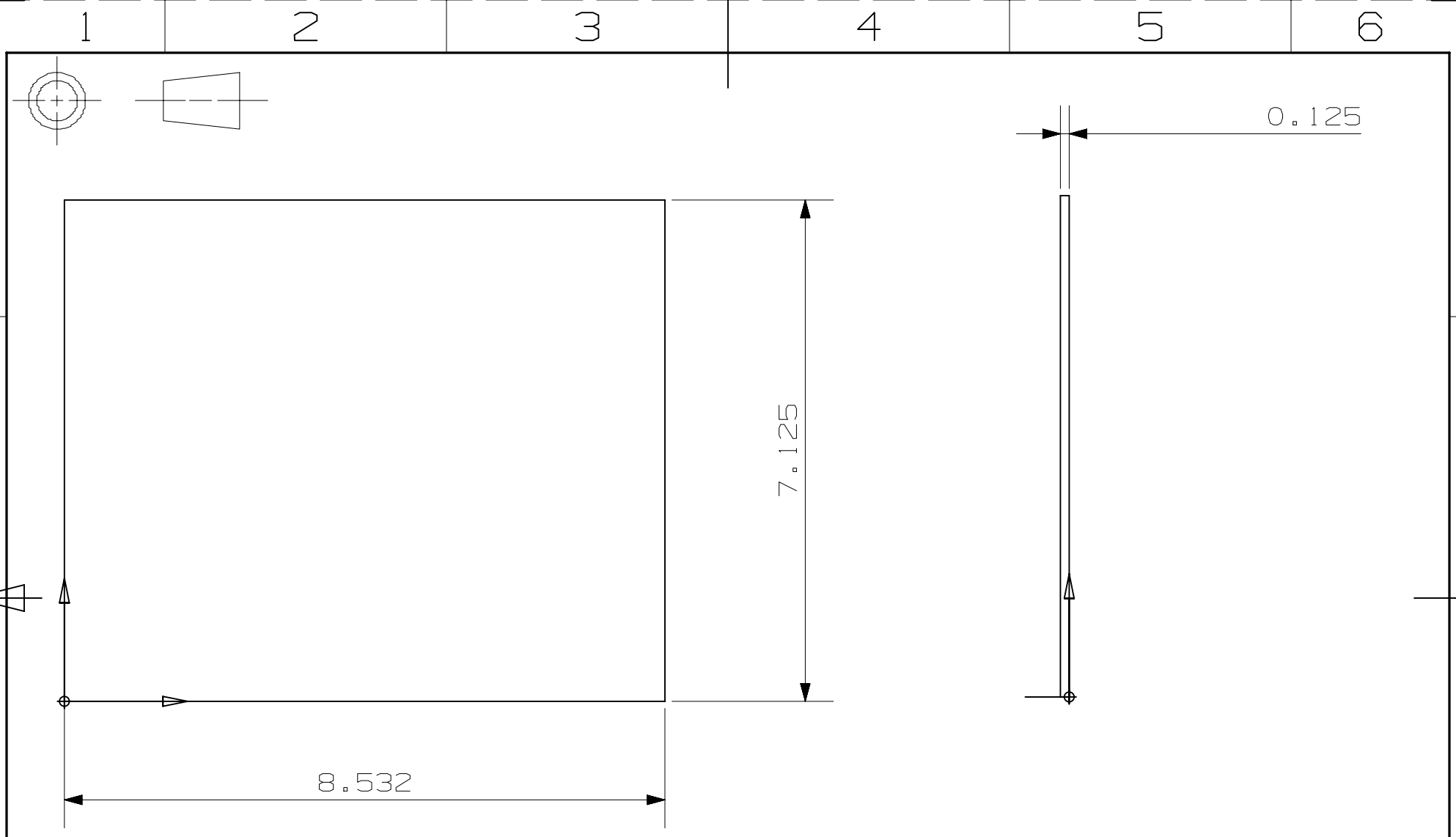

SIEMENS

Michigan Technological University

FIRST ISSUED
 DRAWN BY
 CHECKED BY
 APPROVED BY
 Shawbitz Kevin

TITLE
 Bottom Transmission Line Short
 Brace - Mass Loaded Vinyl

SIZE DRG NO. REV
 A 12 3

ALL DIMENSIONS IN INCHES

3D CAD MASTER PART NAME:

SCALE 1:2

SHEET 1 OF 1

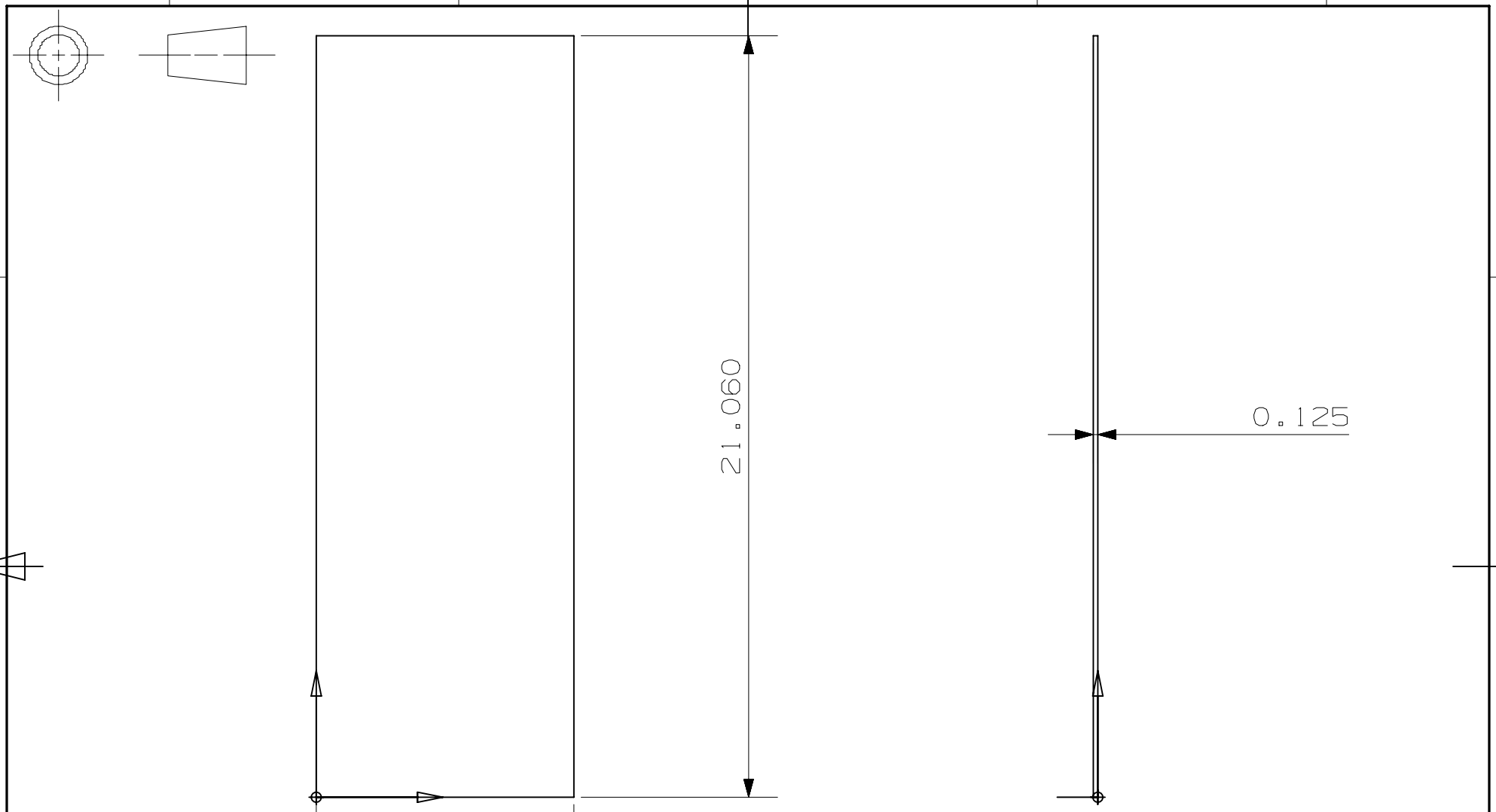

SIEMENS

Michigan Technological University

FIRST ISSUED	
DRAWN BY	
CHECKED BY	
APPROVED BY	
Shawbitz Kevin	

TITLE
Front Transmission Line Long
Brace - Mass Loaded Vinyl

ALL DIMENSIONS IN INCHES
3D CAD MASTER PART NAME:

SIZE	DRG NO.	REV
A	13	3
SCALE 1:4		SHEET 1 OF 1

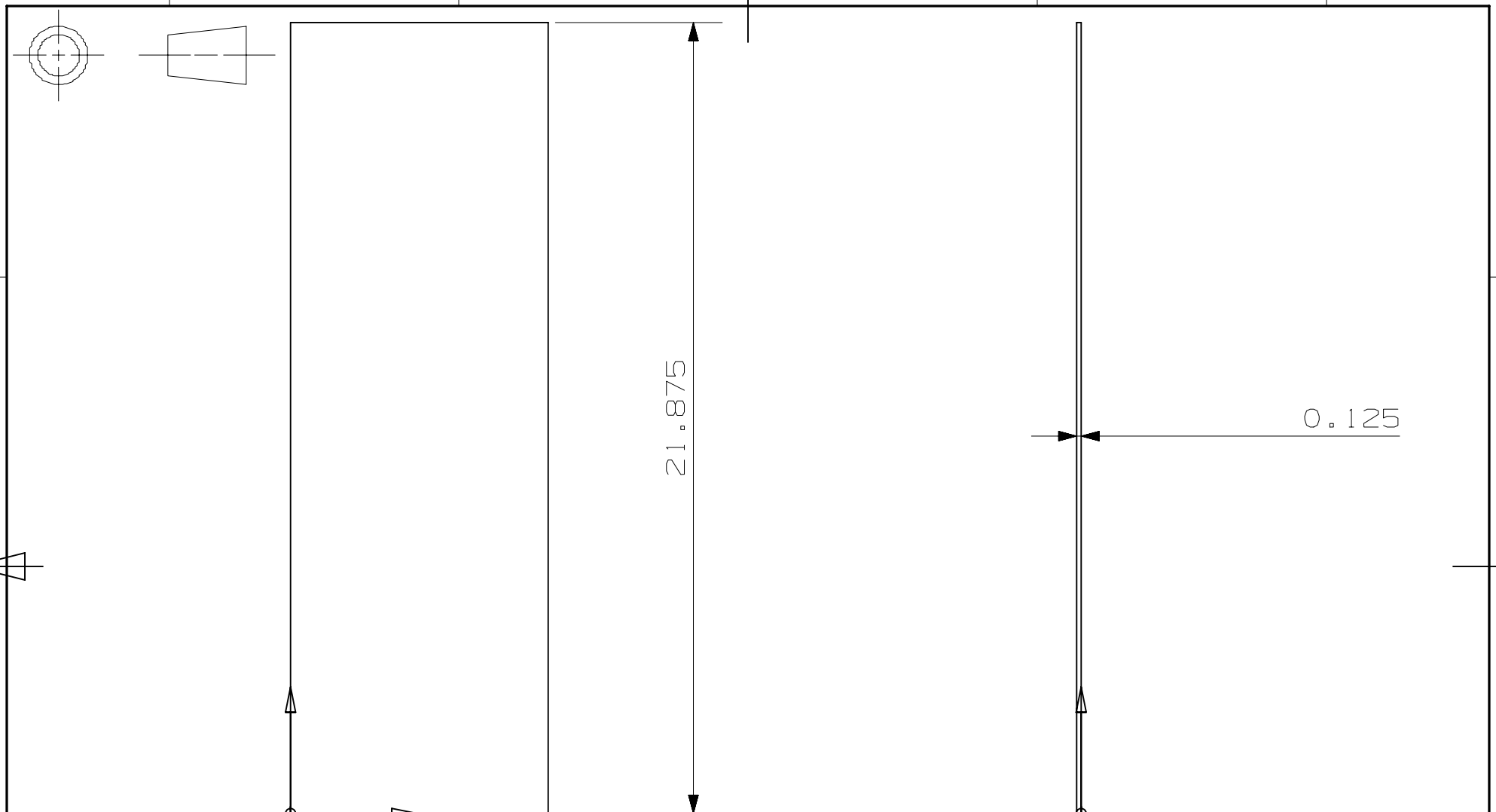

SIEMENS

Michigan Technological University

FIRST ISSUED	
DRAWN BY	
CHECKED BY	
APPROVED BY	
Shawbitz Kevin	

TITLE
Back Transmission Line Long
Brace - Mass Loaded Vinyl

SIZE	DRG NO.	REV
A	14	3

ALL DIMENSIONS IN INCHES
3D CAD MASTER PART NAME:

SCALE 1:4	SHEET 1 OF 1
-----------	--------------

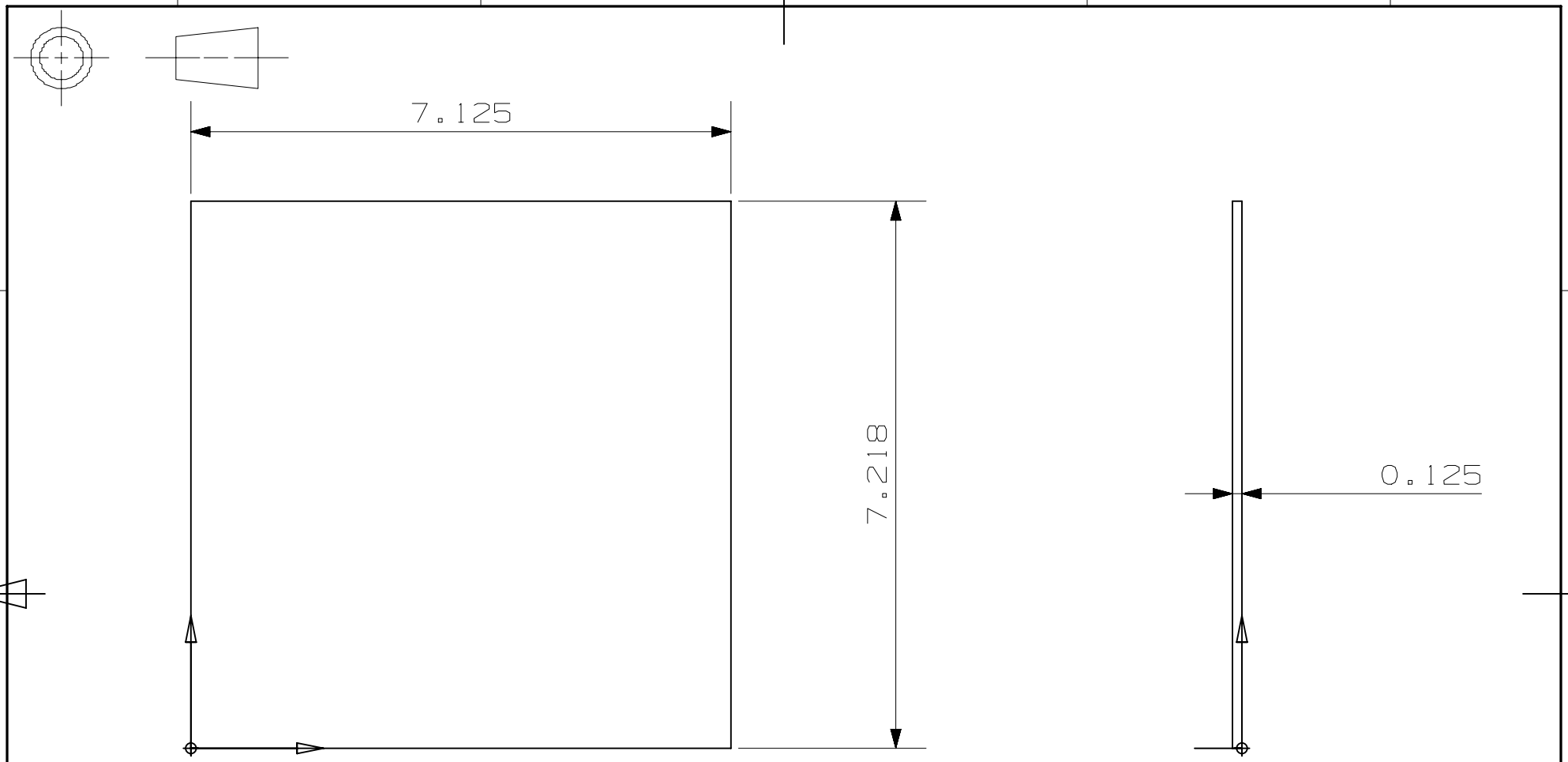

SIEMENS

Michigan Technological University

FIRST ISSUED
 DRAWN BY
 CHECKED BY
 APPROVED BY
 Shawbitz Kevin

TITLE
 Top Transmission Line Short
 Brace - Mass Loaded Vinyl

SIZE DRG NO. REV
 A 15 3

ALL DIMENSIONS IN INCHES

3D CAD MASTER PART NAME:

SCALE 1:2

SHEET 1 OF 1

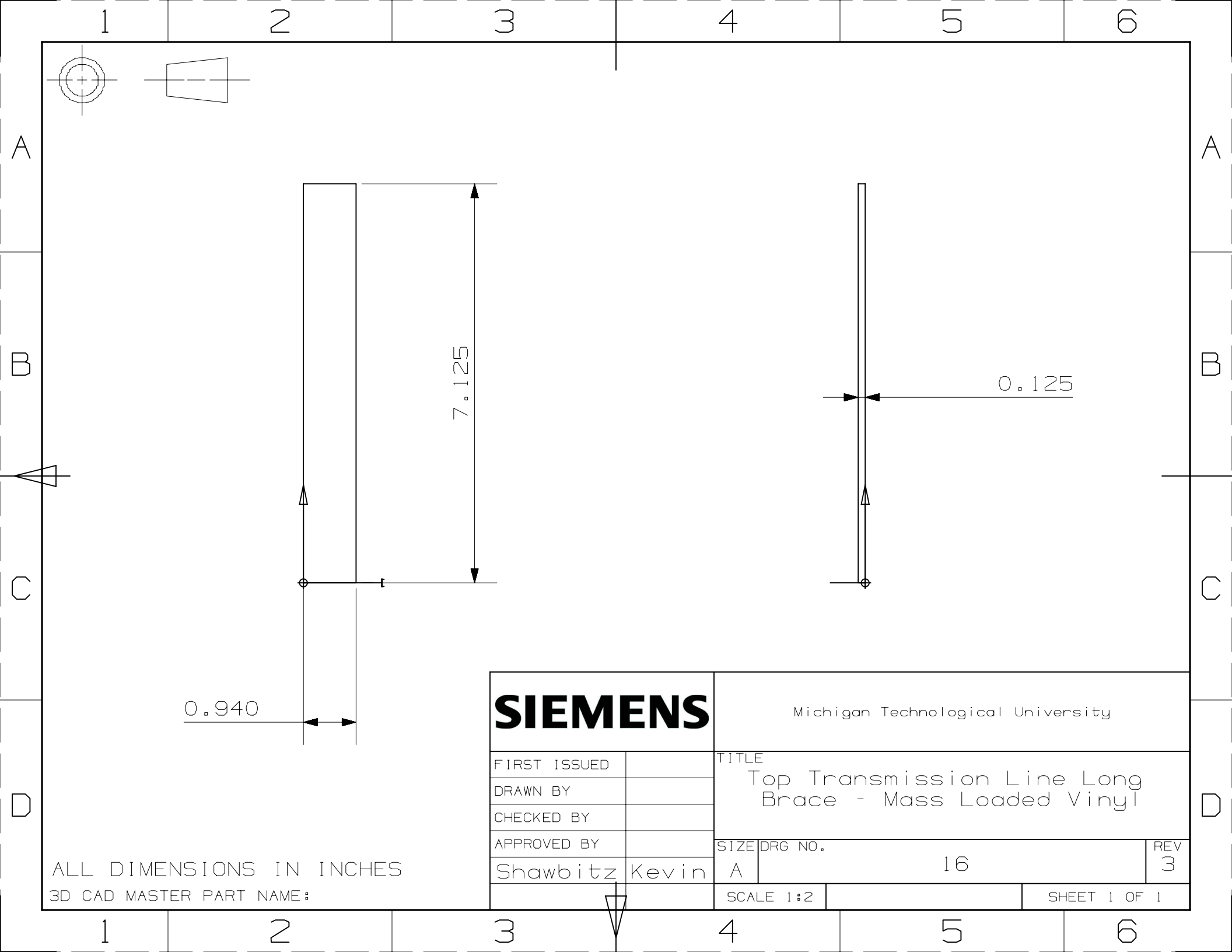

SIEMENS

Michigan Technological University

FIRST ISSUED	
DRAWN BY	
CHECKED BY	
APPROVED BY	
Shawbitz Kevin	

TITLE	
Top Transmission Line Long Brace - Mass Loaded Vinyl	
SIZE	DRG NO.
A	16
	REV
	3

ALL DIMENSIONS IN INCHES
3D CAD MASTER PART NAME :

SCALE 1:2	SHEET 1 OF 1
-----------	--------------